

STRØMBERGS®
STRØMBERGS PLAST AS

7.

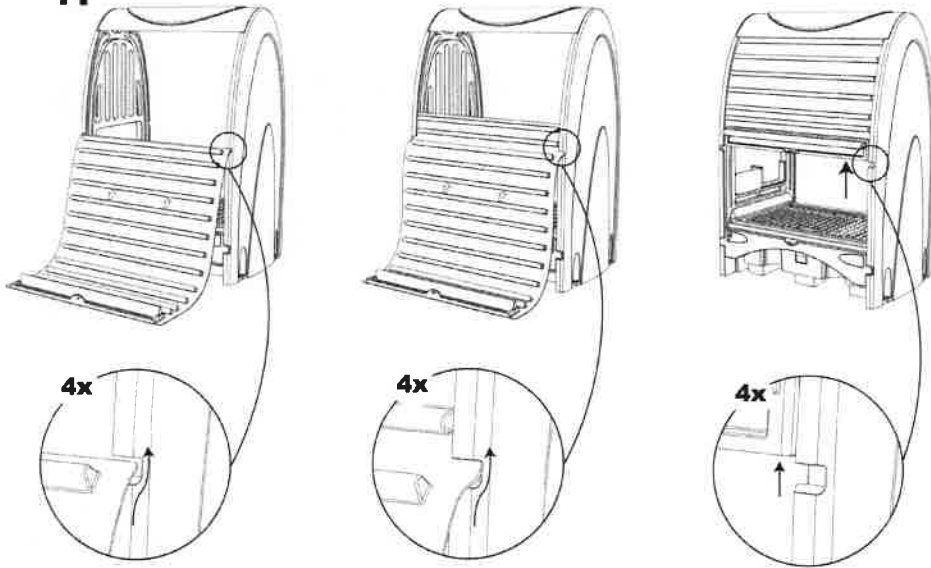

8.

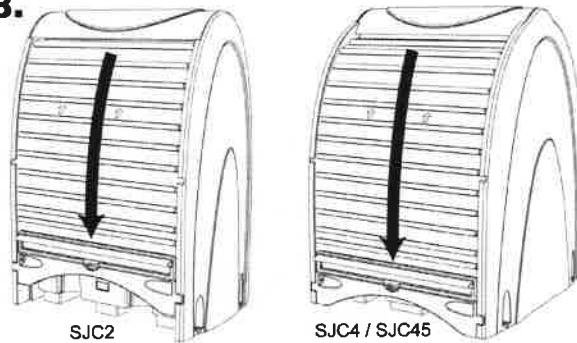

SpillShak

2 & 4 Drum Hard Covers

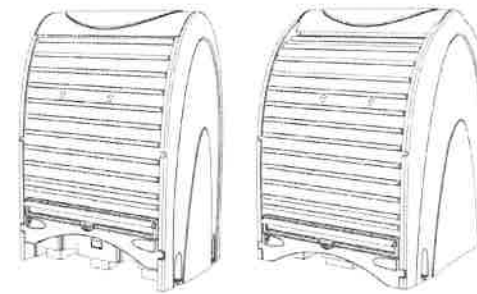

| | mm | mm | | kg |
|--------------|------|------|------|-----|
| SJC2 | 2110 | 1565 | 1100 | 111 |
| SJC4 | 2110 | 1565 | 1730 | 157 |
| SJC45 | 2110 | 1565 | 1730 | 163 |

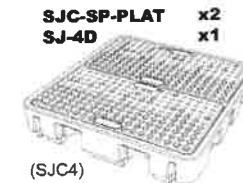
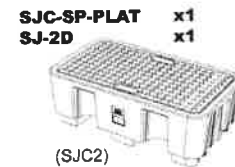
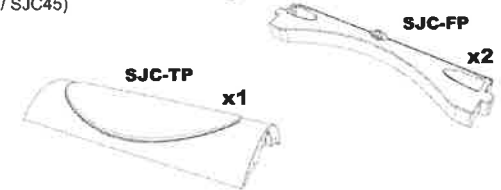
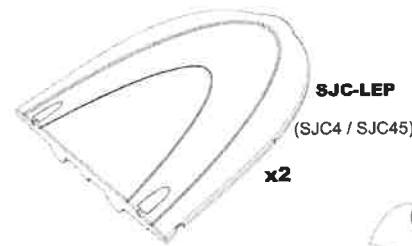
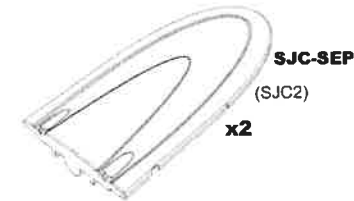
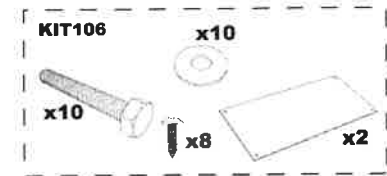

Queries

Please contact Jonesco for any further information or assistance on fitment or other products in the Jonesco range.

UK

Jonesco (Preston) Ltd
Pittman Way, Fulwood
Preston, Lancs.
PR2 9ZD
Tel +44 (0) 1772 706888
Fax +44 (0) 1772 702209
e-mail sales@jonesco-plastics.com

Informations

Pour toutes informations complémentaires ou assistance technique pour le montage de nos produits, veuillez téléphoner.

France

Jonesco S.A.R.L.
SECLIN UNEXPO
1524 Avenue de l'Épinette, 59113 Seclin
Tel +33 (0) 3 20 32 11 11
Fax +33 (0) 3 20 90 62 10
e-mail jonesco@jonesco-fr.com

Anfragen

Bitte fragen Sie an. Wir stehen Ihnen für weitere Auskunft (bzgl. Montage/anderer Jonesco-Produkte) jederzeit zur Verfügung.

Deutschland

Jonesco
Tel +44 (0) 1772 706820
Fax +44 (0) 1772 702209
e-mail sales@jonesco-plastics.com